

- EN** Fitting Instructions for Basic Carrier  
**CZ** Pokyny pro montáž základních nosičů  
**HU** Felszerelési útmutató a tetőcsomagtartóhoz  
**SK** Pokyny pre montáž základných nosičov

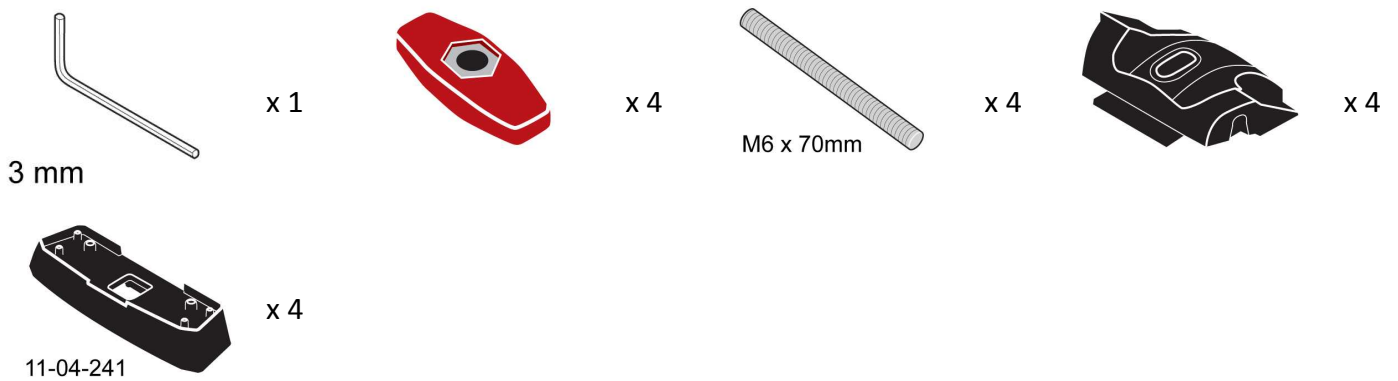

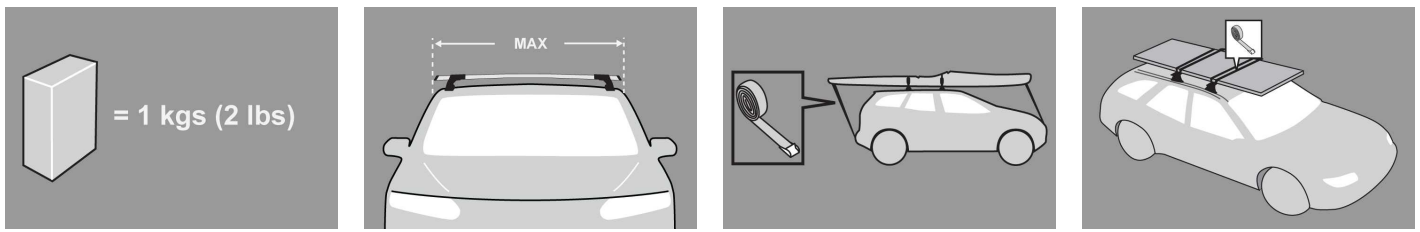

	MAX kgs (lbs)	
	W/P	WHD
<b>Land Rover</b>		
Discovery 3, 5dr SUV 04-05	75 kgs (165 lbs)	100 kgs (220 lbs)
Discovery 3, 5dr SUV 04-09	75 kgs (165 lbs)	100 kgs (220 lbs)
Discovery 3, 5dr SUV 04-09	75 kgs (165 lbs)	100 kgs (220 lbs)
Discovery 3, 5dr SUV 04-09	75 kgs (165 lbs)	100 kgs (220 lbs)
Discovery 4, 5dr SUV 09-+	75 kgs (165 lbs)	100 kgs (220 lbs)
Discovery 4, 5dr SUV 09-+	75 kgs (165 lbs)	100 kgs (220 lbs)
Discovery 4, 5dr SUV 09-+	75 kgs (165 lbs)	100 kgs (220 lbs)
Discovery 4, 5dr SUV 09-+	75 kgs (165 lbs)	100 kgs (220 lbs)
LR3 , 5dr SUV 04-09	75 kgs (165 lbs)	100 kgs (220 lbs)
LR4 , 5dr SUV 09-+	75 kgs (165 lbs)	100 kgs (220 lbs)
Range Rover Sport, 5dr SUV 04-+	75 kgs (165 lbs)	75 kgs (165 lbs)
Range Rover Sport , 5dr SUV 04-+	75 kgs (165 lbs)	75 kgs (165 lbs)
Range Rover Sport , 5dr SUV 05-+	75 kgs (165 lbs)	75 kgs (165 lbs)
Range Rover Sport , 5dr SUV 05-+	75 kgs (165 lbs)	75 kgs (165 lbs)
Range Rover Sport , 5dr SUV 06-+	75 kgs (165 lbs)	75 kgs (165 lbs)

## First Time Installation



- Remove parts from inside the package and check. Contact your dealer if any parts are missing or damaged.



- This kit fits type A, B, C and D.
- These instructions show type A crossbar fitted. They also apply to type B, C and D.



- Use keys to remove covers.



- Use hex screwdriver to reverse adjusting screw 10 turns.



- Press adjusting screw and pull crossbar legs out. Refer to the crossbar instructions for crossbar adjustment.
- Ensure each end of the crossbar is adjusted equally.

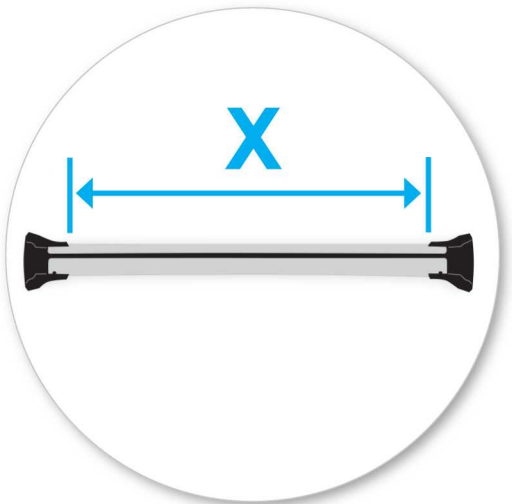

- Adjust crossbar in or out to suit vehicle. Refer to the crossbar instructions for crossbar adjustment.
- Please check the rear of this manual for information relating specifically to your vehicle.

- Tighten adjusting screw to 5 Nm (3.7 ft lb).



- Remove plastic clamp block by gripping bar leg with fingers and push firmly with thumbs until clamp block drops out behind leg.

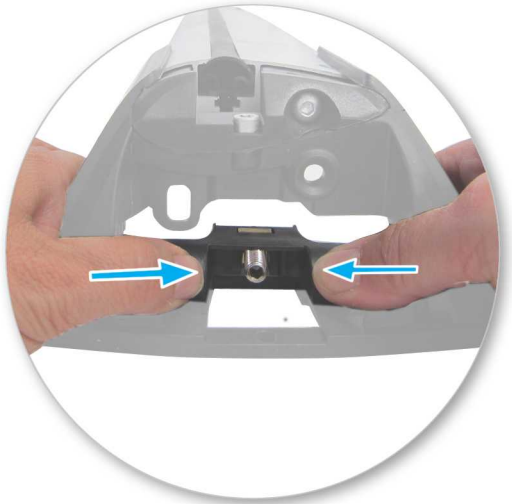

- Select plastic internal block (from fitting kit) and insert into foot.
- Repeat for all legs.





- Fit rubber pads (supplied with fitting kit) to foot. Pad may vary in shape to that shown.
- Make sure the pad fits into the holes underneath the foot.
- Repeat for all legs.

## Fitment



- NOTE: Land Rover Discovery - Do not use front fixpoint
- Locate and remove the small plastic bungs on the roof.
- Store items away in a safe place.



- Select grub screws and screw into the vehicle's fixed points.
- Do not over tighten.
- Repeat for all four positions.



- Place crossbar foot over grub screws.



- Ensure the pads are in the correct position and the clamp threads pass through the crossbar feet.



- Tighten the red plastic knob. The side with the nut showing should be facing up.



- In the fully tightened position, the knobs should be parallel with the vehicle.
- Repeat for all four positions.



- Check crossbar is securely attached to the vehicle.
- Use keys to fit and lock covers

**CAUTION: Recheck all fasteners immediately after a load is applied to the crossbars.  
Regularly check screws are tight.**



## Maintenance

- Clean the car roof and surfaces of the product that will be in contact with the car roof.
- Follow the fitting instructions for fitting the product to your vehicle. Make sure all steps are carried out in order.
- Set crossbars a minimum distance of 700mm (27 1/2") apart where no other distance is specified in the fitting instructions. This is especially important when carrying long loads.
- Check unit is securely attached whenever you refit it to the vehicle. If the unit feels loose, refer to the fitting instructions and readjust.
- Some glass/panoramic roofs and radio antennae may not be able to be used when the product is fitted.
- Do not modify this product.
- Refer to the maximum permitted load capacity specified in the fitting instructions. Do not exceed the vehicle manufacturers roof load rating if it is lower than the maximum load capacity specified in the fitting instructions.
- Loads should not overhang the sides of the product and be evenly distributed with the lowest possible centre of gravity.
- Long loads should be secured with non-elastic straps to the front and rear of the vehicle.
- Objects with pointed ends (e.g. ski poles) should be carried with the pointed ends to the rear of the vehicle.
- Remove all loose or removable objects from the load prior to loading.
- Make sure all loads are securely fastened with non-elastic straps. Check regularly during longer journeys.
- A loaded roof rack system can alter the performance of your vehicle. Be especially aware of the effects of side winds, changing of direction, and braking performance. Avoid rapid acceleration and deceleration. Drive carefully.
- Note that the total height of the vehicle increases when upright loads are carried.
- Products should be locked during transport if they have locks fitted.

- Check and replace worn out or defective parts.
  - Keep the product clean and maintained.
  - Never drive into a car wash with the roof rack system fitted.
  - Lubricate locks and adjusting screws at regular intervals.
  - Remove the products from the vehicle when not in use. Make sure all loose parts are stored safely.
- 

- Yakima Products, Inc.  
15025 SW Koll Pkwy.  
Beaverton, OR 97006-6056  
USA

[www.whispbar.com](http://www.whispbar.com)  
[www.whispbar.ca](http://www.whispbar.ca)  
[www.whispbar.eu](http://www.whispbar.eu)  
[www.whispbar.co.uk](http://www.whispbar.co.uk)  
[www.whispbar.co.za](http://www.whispbar.co.za)

---

## Montáž kitu



- Vyjměte jednotlivé díly z balení a zkontrolujte je. Chybí-li některý díl anebo je poškozen, kontaktujte svého prodejce.

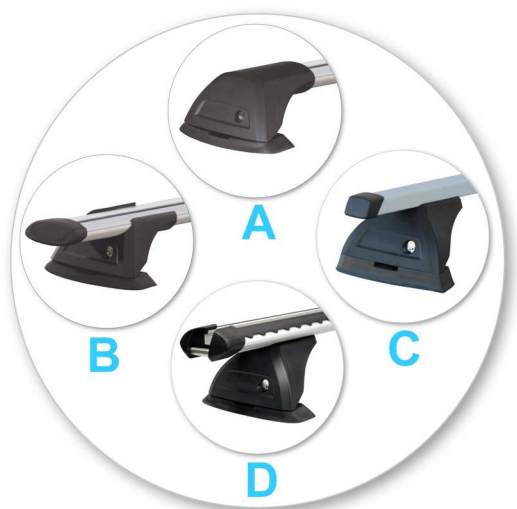

- Tento kit je vhodný pro typy nosičů A, B, C a D.
- Tento manuál zobrazuje montáž pro typ A. Rovněž platí i pro typ B, C a D.



- Pomocí klíče demontujte kryty patek.



- Šestihranným šroubovákem uvolněte nastavovací šroub cca o 10 otáček.



- Zatlačte nastavovací šroub dolů a potáhněte patku směrem ven. Pro nastavení správné délky sledujte montážní manuál nosičů.
- Nastavte oba konce tyče souměrně.

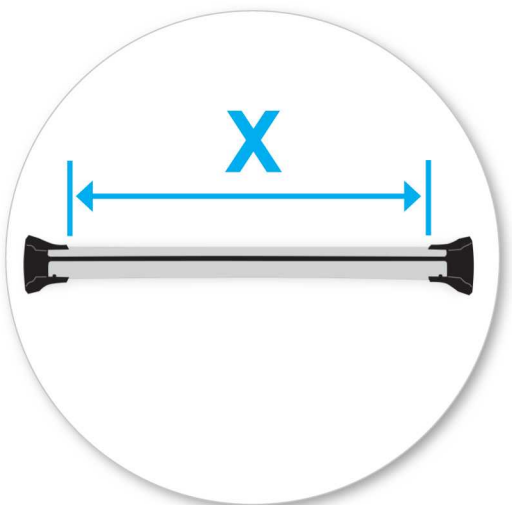

- Délku nosiče nastavte tak, aby vyhovovala rozměrům střechy. Pro nastavení sledujte montážní manuál nosičů.
- Podívejte se do přílohy 1 pro informace týkající se konkrétně Vašeho vozidla.



- Nastavovací šrouby dotáhněte silou 5 Nm / 3.7 ft lb.

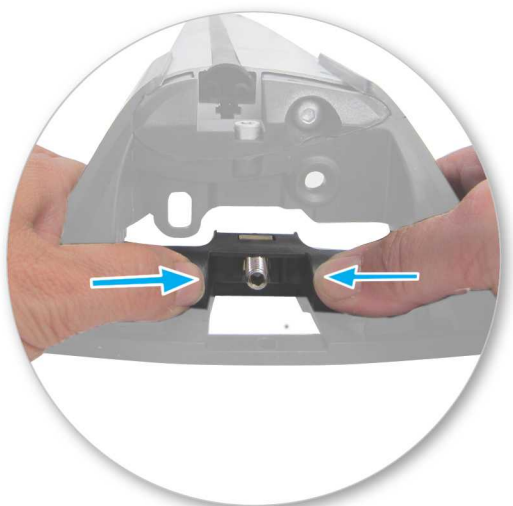

- Z patky vyjměte plastovou redukci jejím zatlačením dozadu.



- Do patky vložte plastovou redukci dodávanou s montážním kitem.
- Zopakujte pro všechny patky nosičů.



- Nasadíte gumové podložky (dodávané s montážním kitem) na patky nosiče. Tvar podložky se může lišit od obrázku.
- Ujistěte se, že podložka zapadá do otvorů na spodní části patky nosiče.
- Zopakujte pro všechny patky nosičů.

## Uchyacení na auto



- Poznámka: Land Rover Discovery - Nepoužívejte přední úchyty.
- Na střeše najděte a odstraňte plastové zátky.
- Uschovejte na bezpečném místě.



- Vyberte šrouby bez hlavy a zašroubujte je do montážních bodů na vozidle.
- Nedotahujte příliš silně.
- Opakujte pro všechny čtyři pozice.

- Nasadíte patku nosiče přes šroub.



- Ujistěte se, že jsou gumové podložky ve správné pozici a spona prochází skrz patku nosiče.



- Utáhněte červenou plastovou matici. Strana s viditelnou kovovou maticí musí směřovat nahoru.





- Písmena odkazují na číslo dílu podložky a pozici.
- Opakujte pro všechny čtyři pozice.



- Zkontrolujte nosič, zda je na vozidle pevně přichycen.
- Pomocí klíče namontujte a zamkněte kryty na patkách.

**UPOZORNĚNÍ:** Ihned po zatížení opět zkontrolujte všechny upevňovací prvky aplikované na střešním nosiči.



## Důležité upozornění

- Očistěte střechu a jednotlivé části výrobků, které budou v kontaktu se střechou vozidla.
- Postupujte podle montážního návodu pro Vaše vozidlo. Ujistěte se, že dodržujete jednotlivé postupy podle daného pořadí.
- Vzdálenost tyčí by měla být minimálně 700 mm (27 1/2") od sebe, pokud není v montážním manuálu uvedena jiná. To je důležité zejména při přepravě dlouhého nákladu.
- Zkontrolujte, zda jsou nosiče pevně namontovány pokaždé, když je dáváte na auto. Je-li cokoliv uvolněno, opravte to podle montážního manuálu.
- Některá střešní okna a autoantény nemůžete používat, je-li nosič namontovaný.
- Neupravujte tento produkt.
- Zkontrolujte maximální zatížení nosičů uvedené v montážním návodu. Nikdy nepřekračujte maximální zatížení střechy povolené výrobcem auta, ani v případě, kdy je nižší než přípustné zatížení nosičů.
- Náklad by neměl přesahovat nosiče do stran, měl by být rozmístěn rovnoměrně a těžiště by mělo být co nejnižší.
- Přepravované dlouhé objekty musí být upevněny neelastickými popruhy k přední i zadní části vozidla.
- Objekty se špičatými konci (lyže) by měli být přepravovány špičatým koncem dozadu.
- Odstráňte všechny volné části nákladu před jeho naložením.
- Ujistěte se, že je náklad na nosičích bezpečně uchycen neelastickými popruhy. Při delších cestách pravidelně kontrolujte uchycení.
- Upozorňujeme, že vozidlo s namontovaným střešním nosičem a převáženým nákladem je náchylnější na boční vítr, reaguje rozdílně na brzdění a akceleraci a má jinou směrovou stabilitu. Jezděte se zvýšenou opatrností.
- Uvědomte si, že celková výška vozidla se zvýší, jakmile naložíte náklad.
- Výrobek by měl být uzamčen i během jízdy (je-li uzamykatelný).

- Pravidelně kontrolujte a vyměňte chybné nebo poškozené díly.
- Udržujte výrobek čistý a v dobrém stavu.
- Nikdy nejezděte do automyčky s namontovaným střešním nosičem.
- Pravidelně promazávejte zámky a šrouby.
- Odmontujte produkty z vozidla, pokud je právě nepoužíváte. Ujistěte se, že jsou všechny díly nosičů bezpečně odložené.

- 
- Yakima Products, Inc.  
15025 SW Koll Pkwy.  
Beaverton, OR 97006-6056  
USA

[www.whispbar.eu](http://www.whispbar.eu)

---

## Első használatba vétel



- A csomagolás kibontása után vegye szemügyre doboz tartalmát. Hiányosság, sérülés esetén lépjen kapcsolatba a forgalmazóval.



- A kitek "A", "B", "C" és "D" típushoz tartozik.
- Az útmutató a "A" kereszttartót mutatja felszerelve. A lépések ugyanúgy érvényesek "B", "C" és "D" típusnál is.



- A takaróelemek levételéhez használja a kulcsot.



- Imbuszfejű csavarhúzó segítségével tekerjen 10 fordulatot kifelé.



- Nyomja be az állítócsavart és húzza ki a kereszttartó lábait. A beállítás menetét megtalálja az útmutatóban.
- Ügyeljen arra, hogy a kereszttartó lábai megegyező módon álljanak.

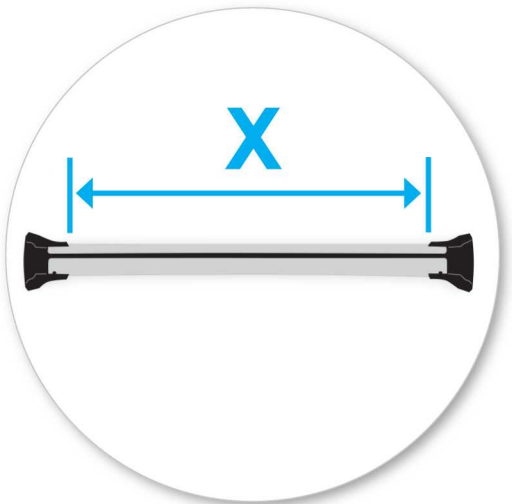

- Állítsa autójához, megfelelő hosszúságúra a kereszttartót. Az állítás módját keresse a kereszttartó beállítási útmutatójánál.
- Autójára vonatkozó adatokat kérjük tekintse meg az útmutató végén található leírásban.



- 5 Nm / 3.7 ft lb erővel húzza meg az állítócsavart.

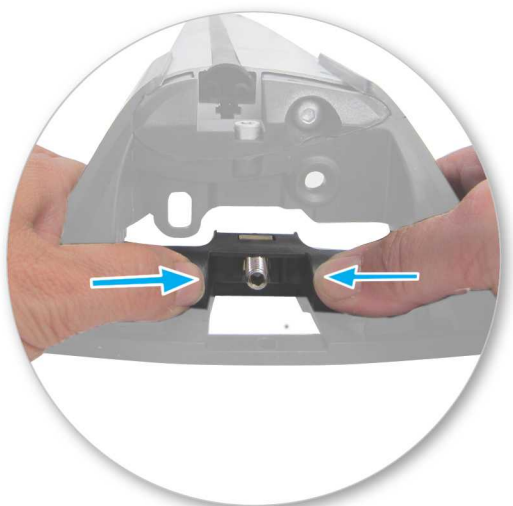

- Hátrafelé tolva távolítsa el a rögzítő konzolt.



- A kitben található középső rögzítő konzolt illessze a kereszttartó lábhoz.
- Mind a négy ponton ismételje meg a lépéseket.



- Illessze a készletben található gumitalpat a kereszttartó talpához. Alakja eltérő lehet a képen szereplőtől.
- Ügyeljen rá, hogy a talp beleillesszékjen a kereszttartó láb furataiba.
- Mind a négy ponton ismételje meg a lépéseket.

## Illesztés



- FIGYELEM: Land Rover Discovery - Ne használja az elől lévő fix rögzítési pontot.
- Távolítsa el a műanyag fedődugókat.
- Tárolja az elemeket biztonságos helyen.



- Tekerje a csavart a menetes furatokba meg a jármű rögzítési pontjait.
- Ügyeljen arra, hogy ne szakítsa meg a menetet.
- Mind a négy alkatrésznél ismételje meg ezt a lépést.



- Helyezze a kereszttartót a rögzítő csavarokra.



- Győződjön meg róla, hogy a talpak megfelelő helyzetben állnak-e és, hogy a rögzítő menet túlnyúlik-e a kereszttartó lábán.



- Húzza meg a piros, műanyag zárgombot. Ügyeljen arra, hogy az anyát befoglaló része essen fölfelé.



- Ügyeljen rá, hogy a zárógombok, az autó oldalával párhuzamos helyzetben álljanak meghúzott állapot mellett.
- Mind a négy alkatrésznél ismételje meg ezt a lépést.



- Győződjön meg róla, hogy a kereszttartók megfelelően rögzülnek-e az autóhoz.
- A takaróelemek le- és felszereléséhez, illetve zárásához használjon kulcsot.

**FIGYELEM: Rendszeresen ellenőrizze a csavarok szorosságát.**



## Kezelési tanácsok

- Tisztítsa meg az autótető és a tetőcsomagtartó azon részeit melyek érintkeznek egymással.
- A tetőcsomagtartó felszereléséhez kövesse az útmutatóban található utasításokat. Ügyeljen a pontos sorrendre.
- Ha nem található erre vonatkozó leírás, akkor is minimum 700 mm távolságra helyezze egymástól a kereszttartókat. Nagyon fontos, főként nagy hosszal rendelkező csomagok szállítása esetén.
- Minden egyes felszerelés alkalmával győződjön meg a rögzítés stabilitásáról. Ha szükséges, az útmutató segítségével végezze el ismét a beállításokat.
- Néhány napfénytető és antenna nem használható a tetőcsomagtartóval egyidejűleg.
- Ne módosítson a termék alkatrészein.
- Figyeljen az útmutatóban található maximális terhelhetőségre vonatkozó adatokra. Ha az autó gyártója kevesebb terhelhetőséget enged meg, mint amit az útmutatóban talál, az kisebb értéket vegye figyelembe.
- Ügyeljen rá, hogy a szállítandó terhek ne haladják meg nagy mértékben a tetőcsomagtartó teljes szélességét. Igyekezzen egyenletesen elosztani a szállítandó csomagokat, a lehető legalacsonyabb tömegközpontról elrendezés mellett.
- Hosszú, túlméretes csomagok szállítása esetén gondoskodjunk a megfelelő rögzítésről. Használjunk nem nyúló anyagból készült rögzítőhevedereket.
- A éles sarkokkal rendelkező tárgyak (pl.: síléc) szállításánál ügyeljen arra, hogy az élek az autó hátulja felé essenek.
- Távolítsa el az összes lazán illeszkedő, illetve leszerelhető részt a szállítani kívánt tárgyról.
- Ügyeljen rá, hogy minden csomag gondosan rögzítve legyen. Hosszabb utazás során, időnként ellenőrizze a hevederek feszességét.

- A megterhelt tetőcsomagtartó rendszer befolyásolhatja járműve haladási képességeit. Kérjük fokozottan ügyeljen az oldalszél hatásaira, a menetirány megváltoztatására és a fékezés módjára. Kerülje a hirtelen gyorsításokat, lassításokat. Vezessen óvatosan.
- Legyen körültekintőbb, a csomagok miatt megváltozott autó-magasság miatt.
- Szállítás közben tartsa zárva azon eszközöket melyek rendelkeznek zárral.
- Ellenőrizze az alkatrészeket, elhasználódás illetve meghibásodás esetén cserélje azokat.
- Igyekezzen tisztán és gondosan karbantartani a terméket.
- Ne mosassa autóját gépi autómosóban ha a tetőcsomagtartó fel van szerelve.
- Gondoskodjon a zárok és állítócsavarok időnkénti kenéséről.
- Amennyiben egyáltalán nem használja a termék(ek)et, úgy lehetőség szerint szerelje le az autóról. Az apróbb, lazán illeszkedő alkatrészeket tárolja biztos helyen.

- 
- Yakima Products, Inc.  
15025 SW Koll Pkwy.  
Beaverton, OR 97006-6056  
USA

[www.whispbar.eu](http://www.whispbar.eu)

---

## Montáž kitu



- Vyberte jednotlivé diely z balenia a skontrolujte ich. Kontaktujte svojho predajcu, ak niektorý diel chýba alebo je poškodený.



- Tento kit je vhodný pre typy nosičov A, B, C a D.
- Tento manuál zobrazuje montáž pre typ A. Rovnako platí aj pre typ B, C aj D.



- Pomocou kľúča demontujte kryty pätiiek.



- Šesťhranným skrutkovačom uvoľnite nastavovaciu skrutku o 10 otáčok.



- Zatlačte nastavovaciu skrutku a potiahnite pätku smerom von. Pre nastavenie správnej dĺžky pozrite montážny manuál nosičov.
- Nastavte oba konce tyče súmerne.

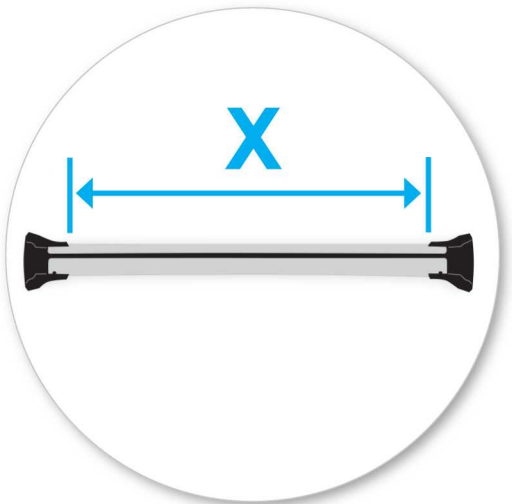

- Nastavte dĺžku nosiča tak, aby vyhovovala rozmerom strechy. Pre nastavenie pozrite montážny manuál nosičov.
- Pozrite prílohu 1 pre informácie týkajúce sa konkrétne Vášho vozidla.



- Dotiahnite nastavovacie skrutky silou 5 Nm / 3.7 ft lb.

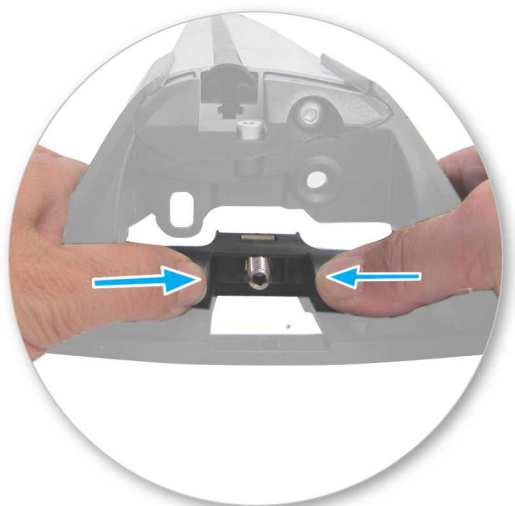

- Zachytením nastavca tyče prstami odstráňte plastovú zámku svorky a palcami pevne zatlačte, až kým za nastavcom nevypadne zámka svorky.



- Zložte do pätky plastovú redukciu dodávanú s montážnym kitom.
- Zopakujte pre všetky pätky nosičov.



- Nasadíte gumené podložky (dodávané s montážnym kitom) na pätky nosiča. Tvar podložky sa môže líšiť od obrázku.
- Uistite sa, že podložka zapadá do otvorov na spodnej časti pätky nosiča.
- Zopakujte pre všetky pätky nosičov.

## Uchytenie na auto



- Poznámka: Land Rover Discovery - Nepoužívajte predné úchyty.
- Nájdite a odstráňte plastové zátky na streche.
- Uschovajte na bezpečnom mieste.



- Vyberte skrutky bez hlavy a zaskrutkujte ich do montážne body na vozidle.
- Nedotáhajte príliš silno.
- Opakujte pre všetky štyri pozície.



- Nasadíte pätku nosiča cez skrutku.



- Uistite sa, že gumené podložky sú v správnej pozícii a spona prechádza cez pätku nosiča.



- Utiahnite červenú plastovú maticu. Strana s viditeľnou kovovou maticou musí smerovať nahor.



- Písmená odkazujú na číslo dielu podložky a pozíciu.
- Opakujte pre všetky štyri pozície.



- Skontrolujte nosič, či je pevne pripevnený na vozidle.
- Pomocou kľúča namontujte a zamknite kryty na pätkách.

**UPOZORNENIE: Pravidelne kontrolujte správnosť dotiahnutia skrutiek.**



## Dôležité upozornenia

- Očistite strechu a jednotlivé časti výrobkov, ktoré sa budú dotýkať strechy vozidla.
- Postupujte podľa montážneho postupu pre Vaše vozidlo. Uistite sa, že dodržiavate jednotlivé postupy podľa daného poradia.
- Vzďialenosť tyčí by mala byť minimálne 700mm od seba, pokiaľ v montážnom manuály nie je udávaná iná. To je dôležité najmä pri preprave dlhého nákladu.
- Skontrolujte, či sú nosiče pevne zmontované zakaždým, keď ich dávate na auto. Ak je čokoľvek uvoľnené, opravte to podľa montážneho manuálu.
- Ak je pripevnený tento výrobok, niektoré sklenené/panoramatické strechy a rádiovú anténu možno nebude možné použiť.
- Neupravujte tento produkt.
- Skontrolujte maximálne zaťaženie nosičov uvedené v montážnom návode. Nikdy neprekračujte maximálne zaťaženie strechy povolené výrobcom auta, ani v prípade, keď je nižšie ako prípustné zaťaženie nosičov.
- Náklad by nemal presahovať nosiče do strán, mal by byť rozmiestnený rovnomerne a ťažisko by malo byť čo najnižšie.
- Prepravované dlhé objekty musia byť upevnené neelastickými popruhmi k prednej aj zadnej časti vozidla.
- Objekty so špicatými koncami (lyže) mali by byť prepravované špicatým koncom dozadu.
- Odstráňte všetky voľné časti nákladu pred jeho naložením.
- Uistite sa, že náklad na nosičoch je bezpečne uchytený neelastickými popruhmi. Pri dlhších cestách pravidelne kontrolujte uchytenie.
- Upozorňujeme, že vozidlo s namontovaným strešným nosičom a prevážaným nákladom je náchylnejšie na bočný vietor, reaguje rozdielne na brzdenie a akceleráciu a má inú smerovú stabilitu. Jazdite so zvýšenou opatrnosťou.
- Uvedomte si, že celková výška vozidla sa zvýši, ak naložíte batožinu.
- Výrobok by mal byť zamknutý aj počas jazdy (ak je uzamykateľný).

- Pravidelne skontrolujte a vymeňte chybné alebo poškodené diely.
- Udržiavajte výrobok čistý a v dobrom stave.
- Nikdy nevchádzajte do autoumyvárky s namontovaným strešným nosičom.
- Pravidelne namažte zámky a skrutky.
- Odmontujte produkty z vozidla, ak ich práve nepoužívate. Uistite sa, že všetky diely nosičov sú bezpečne odložené.

- 
- Yakima Products, Inc.  
15025 SW Koll Pkwy.  
Beaverton, OR 97006-6056  
USA

[www.whispbar.sk](http://www.whispbar.sk)

---

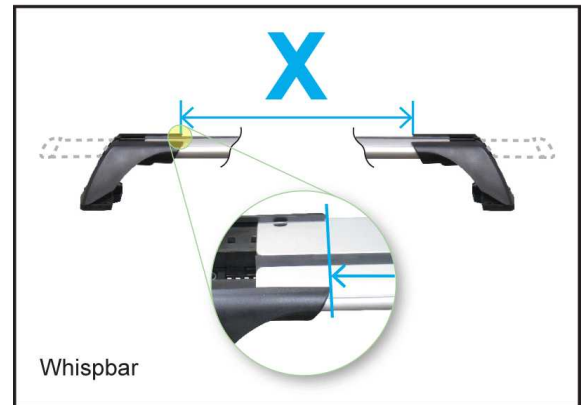
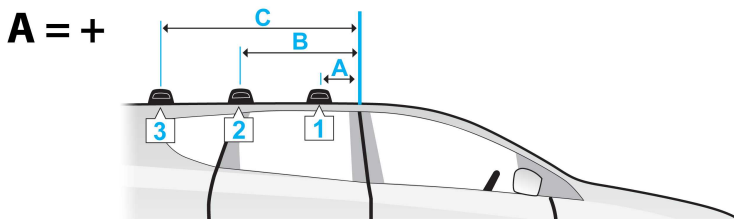
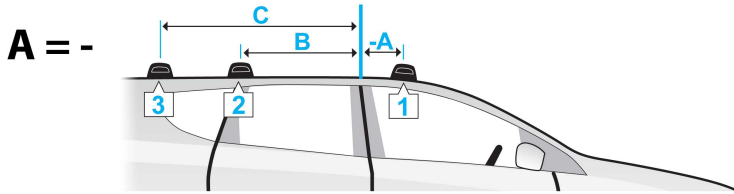

	<b>X</b>					
	<b>A</b>	<b>B</b>	<b>C</b>	<b>1</b>	<b>2</b>	<b>3</b>
Discovery, 5dr SUV 04-05 (ZA)	-330mm -12 -1/16ths"	250mm 9 13/16ths"	840mm 33 1/16ths"	- -	950mm 37 3/8ths"	935mm 36 13/16ths"
Discovery, 5dr SUV 04-09 (NZ)	-330mm -12 -1/16ths"	250mm 9 13/16ths"	840mm 33 1/16ths"	- -	950mm 37 3/8ths"	935mm 36 13/16ths"
Discovery, 5dr SUV 04-09 (AU)	-330mm -12 -1/16ths"	250mm 9 13/16ths"	840mm 33 1/16ths"	- -	950mm 37 3/8ths"	935mm 36 13/16ths"
Discovery, 5dr SUV 04-09 (EU)	-330mm -12 -1/16ths"	250mm 9 13/16ths"	840mm 33 1/16ths"	- -	950mm 37 3/8ths"	935mm 36 13/16ths"
Discovery, 5dr SUV 09+ (ZA)	-330mm -12 -1/16ths"	250mm 9 13/16ths"	840mm 33 1/16ths"	- -	950mm 37 3/8ths"	935mm 36 13/16ths"
Discovery, 5dr SUV 09+ (NZ)	-330mm -12 -1/16ths"	250mm 9 13/16ths"	840mm 33 1/16ths"	- -	950mm 37 3/8ths"	935mm 36 13/16ths"
Discovery, 5dr SUV 09+ (AU)	-330mm -12 -1/16ths"	250mm 9 13/16ths"	840mm 33 1/16ths"	- -	950mm 37 3/8ths"	935mm 36 13/16ths"
Discovery, 5dr SUV 09+ (EU)	-330mm -12 -1/16ths"	250mm 9 13/16ths"	840mm 33 1/16ths"	- -	950mm 37 3/8ths"	935mm 36 13/16ths"
LR3, 5dr SUV 04-09 (US)	-330mm -12 -1/16ths"	250mm 9 13/16ths"	840mm 33 1/16ths"	- -	950mm 37 3/8ths"	935mm 36 13/16ths"
LR4, 5dr SUV 09+ (US)	-330mm -12 -1/16ths"	250mm 9 13/16ths"	840mm 33 1/16ths"	- -	950mm 37 3/8ths"	935mm 36 13/16ths"
Range Rover , 5dr SUV 04+ (ZA)	-200mm -7 -7/8ths"	380mm 14 15/16ths"	940mm 37"	1040mm 40 15/16ths"	1030mm 40 9/16ths"	1015mm 39 15/16ths"
Range Rover Sport, 5dr SUV 04+ (EU)	-200mm -7 -7/8ths"	380mm 14 15/16ths"	940mm 37"	1040mm 40 15/16ths"	1030mm 40 9/16ths"	1015mm 39 15/16ths"
Range Rover Sport, 5dr SUV 05+ (AU)	-200mm -7 -7/8ths"	380mm 14 15/16ths"	940mm 37"	1040mm 40 15/16ths"	1030mm 40 9/16ths"	1015mm 39 15/16ths"
Range Rover Sport, 5dr SUV 05+ (NZ)	-200mm -7 -7/8ths"	380mm 14 15/16ths"	940mm 37"	1040mm 40 15/16ths"	1030mm 40 9/16ths"	1015mm 39 15/16ths"
Range Rover Sport, 5dr SUV 06+ (US)	-200mm -7 -7/8ths"	380mm 14 15/16ths"	940mm 37"	1040mm 40 15/16ths"	1030mm 40 9/16ths"	1015mm 39 15/16ths"

**LIMITED LIFETIME WARRANTY**

Technical Assistance or Replacement Parts: Contact your dealer or visit: [www.whispbar.com](http://www.whispbar.com) or call (888) 925-4621 Monday through Friday, 7:00am to 5:00pm, PST

This limited lifetime warranty covers all Whispbar-brand products\* and rack components manufactured by Yakima Products, Inc. (Yakima), and is effective for as long as the original retail purchaser owns the product. This warranty terminates when the original retail purchaser sells or otherwise transfers the product to any other person. Subject to Yakima's inspection of the product, Yakima will remedy defects in materials and/or workmanship by repairing or replacing, at Yakima's option, the defective product without charge for parts or labor, subject to the limitations and exclusions described in this warranty. Yakima may elect, at its option, not to repair or replace a defective product, in which case Yakima will issue to the original retail purchaser, at Yakima's option, either a refund equal to the purchase price paid for the product, or a credit to be used toward the purchase of new Whispbar products or rack components. This warranty does not cover problems caused by normal wear and tear (including, but not limited to, scratches, dents, or aesthetic oxidation of surfaces), accidents, unlawful vehicle operation, or modifications or repairs not performed or authorized by Yakima. In addition, this warranty does not cover problems resulting from conditions beyond Yakima's control including, but not limited to, theft, misuse, overloading, or failure to assemble, mount or use the product in accordance with Yakima's written instructions or guidelines included with the product or made available to the original retail purchaser. If a product is believed to be defective, the original retail purchaser should contact the Whispbar dealer from whom it purchased the product, who will give the original retail purchaser instructions on how to proceed. If the original retail purchaser is unable to contact the Whispbar dealer, or the dealer is not able to remedy the defect, the original retail purchaser should contact Yakima by e-mail at: [yakwarranty@yakima.com](mailto:yakwarranty@yakima.com), or phone 888.925.4621 for shipping instructions. Upon contacting Yakima directly, a Yakima technician will provide the original retail purchaser with appropriate instructions for returning the product to Yakima. The original retail purchaser will be responsible for the cost of mailing the product to Yakima. In order to receive any remedy under this warranty (either from a Whispbar dealer, or from Yakima directly), proof of purchase in the form of an original purchase invoice or receipt is strictly required.

**LIMITATION OF LIABILITY**

REPAIR OR REPLACEMENT OF A DEFECTIVE PRODUCT, OR THE ISSUANCE OF A REFUND OR CREDIT (AS DETERMINED BY YAKIMA), IS THE ORIGINAL RETAIL PURCHASER'S EXCLUSIVE REMEDY UNDER THIS WARRANTY. DAMAGE OR INJURY TO THE ORIGINAL RETAIL PURCHASER, TO HIS OR HER VEHICLE, CARGO, OR PROPERTY, AND/OR TO ANY OTHER PERSON OR PROPERTY IS NOT COVERED BY THIS WARRANTY. THIS WARRANTY IS EXPRESSLY MADE IN LIEU OF ANY AND ALL OTHER EXPRESS WARRANTIES, WHETHER ORAL OR WRITTEN.

YAKIMA'S SOLE LIABILITY IS LIMITED TO THE REMEDY SET FORTH ABOVE. IN NO EVENT WILL YAKIMA BE LIABLE FOR ANY DIRECT, INDIRECT, CONSEQUENTIAL, INCIDENTAL, SPECIAL, EXEMPLARY, OR PUNITIVE DAMAGES OR FOR ANY OTHER DAMAGES OF ANY KIND OR NATURE (INCLUDING, BUT NOT LIMITED TO, LOST PROFITS OR LOST SALES).

SOME STATES DO NOT ALLOW THE EXCLUSION OR LIMITATION OF INCIDENTAL OR CONSEQUENTIAL DAMAGES, SO THE ABOVE LIMITATIONS MAY NOT APPLY TO YOU.

THIS WARRANTY GIVES YOU SPECIFIC LEGAL RIGHTS, AND YOU MAY ALSO HAVE OTHER RIGHTS WHICH VARY FROM STATE TO STATE.

**WARRANTY & DISCLAIMER**

**Yakima Australia Pty Ltd ABN 58 154 440 221**  
**17 Hinkler Court, Brendale QLD 4500**  
**Tel: 0800 4776 722 (NZ) or 1800 143 548 (AU)**  
**Email: warranty@yakima.co.nz or warranty@yakima.com.au**

1. Where the product is supplied to the customer for other than business purposes within the meaning of section 43 of the New Zealand Consumer Guarantees Act 1993, the provisions of that Act shall apply. It is important that anyone who fits or uses this product does so in accordance with the manufacturer's instructions.
2. Where the product is supplied to the customer for business purposes within the meaning of section 43 of the New Zealand Consumer Guarantees Act 1993, the provisions of that Act and all other representations or terms (including any conditions or warranty expressed or implied by law, statute or otherwise) not expressly included in this leaflet are hereby expressly excluded shall have no effect and the clauses (a) and (b) shall apply.
3. Subject to the **Additional Information (Australia)**, where the product is supplied and purchased in Australia, the following shall apply:
  - a. THE SUPPLIER WARRANTS the product to be free from defects in materials and/or workmanship for a limited lifetime from the date of original purchase (the warranty period). Proof of purchase is required. Subject to the limitations and exclusions set out below, the Supplier hereby agrees to remedy any defects in materials or workmanship becoming apparent during the warranty period, by replacing or repairing any defective product or component (at its option) free of charge to the purchaser in respect of replacement parts or labour. Any defective product or component must be notified and where practicable, returned at the purchaser's expense to the Supplier immediately upon discovery of the alleged defect and no attempt made on the part of the purchaser to repair it.
  - b. EXCEPTIONS, EXCLUSIONS AND LIMITATIONS TO WARRANTY. The product and/or its components must be fitted/ assembled and loaded in accordance with the Supplier's written instructions and any requirements set out in the car's owner manual. This warranty does not cover defects, loss or damage resulting from circumstances beyond the Supplier's control including, but not limited to misuse, overloading, or failure to assemble and/or fit the product or component in accordance with the Supplier's written instructions. Nor does the warranty cover defects, loss or damage resulting from accidents, unlawful use of the vehicle or defects/inconsistencies in the vehicle on which the product or component is fitted. Liability for direct, indirect, special, punitive, incidental, exemplary, contractual or consequential damage or loss arising from defects, faulty materials or design omissions or negligence or workmanship in the product or its components is hereby expressly excluded subject to the following. Certain Commonwealth legislation, including the Competition and Consumer Act 2010 (Cth), and other State and Territorial legislation confers upon purchasers rights which cannot be excluded from or be restricted or modified by contract. Any conditions, guarantees and/or warranties implied by law and incapable of exclusion are deemed to be expressly incorporated herein. Nothing herein contained is intended nor shall be permitted to be inconsistent with any such conditions, guarantees and/or warranties. To the extent permitted by legislation all conditions, guarantees and/or warranties such as implied warranties which are capable of exclusion are hereby expressly excluded and negated.

**ADDITIONAL INFORMATION ( AUSTRALIA )**

This information should be read in conjunction with clauses (a) and (b).

**IMPORTANT LEGAL NOTICE**

Our goods come with guarantees that cannot be excluded under the Australian Consumer Law. You are entitled to a replacement or refund for a major failure and for compensation for any other reasonably foreseeable loss or damage. You are also entitled to have the goods repaired or replaced if the goods fail to be of acceptable quality and the failure does not amount to a major failure.

This warranty does not change or take away your rights under the Australian Consumer Law. Your right to claim under this policy for the benefits covered is in addition to other rights and remedies you have under the law in relation to the product.

Where you become aware of defects in materials or of workmanship, and wish to make a claim under this warranty you must do the following for the warranty to be honoured by your Whispbar dealer or Yakima Australia Pty Ltd ABN 58 154 440 221 (Yakima):

1. Make a claim as soon as practicable by contacting the Whispbar dealer from whom you purchased the product, who will give you instructions on how to proceed.
2. If you are unable to contact the Whispbar dealer, or the dealer is not able to remedy the defect, you should contact Yakima as soon as practicable at:  
 Call: 0800 4776 722 (NZ) or 1800 143 548 (AU)  
 Email: warranty@yakima.co.nz or warranty@yakima.com.au

Alternately, you can write to Yakima at 17 Hinkler Court, Brendale QLD Australia 4500 in order to make a claim under your warranty.

3. Upon contacting Yakima directly, you should explain as fully as possible the defect. A Yakima representative will provide you with appropriate instructions for returning the product together with a copy of the original purchase invoice or receipt to Yakima.

4. The costs and expenses associated with making a claim under your warranty including the costs of complying with those instructions and of returning the product to Yakima or the Whispbar dealer will be borne by you.

Following receipt of the product and purchase invoice or receipt, Yakima or the Whispbar dealer must inspect the product to determine whether the claim falls within the warranty. If:

- 4.1 the claim falls within the warranty, Yakima will remedy any defects in materials or workmanship becoming apparent during the warranty period, by replacing or repairing any defective product or component (at its option) free of charge to the purchaser in respect of replacement parts or labour.
- 4.2 the claim does not fall within the warranty, Yakima will return the product to you at your expense.