

OPTIONAL KIT 0153

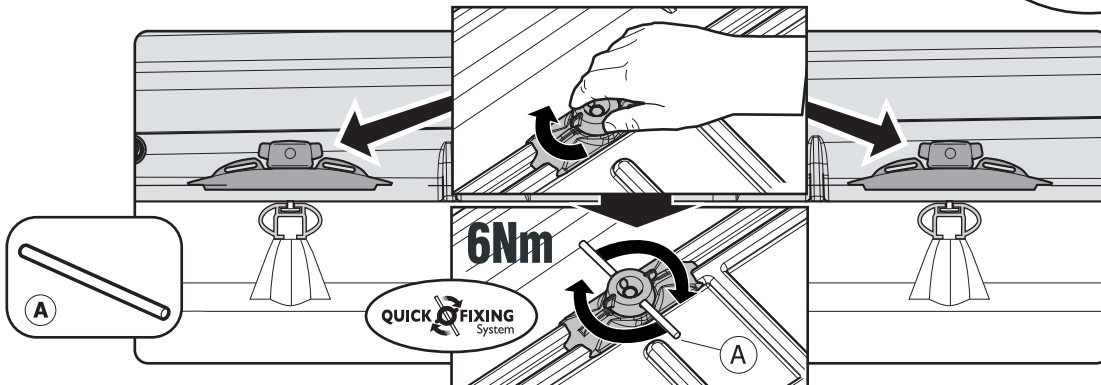
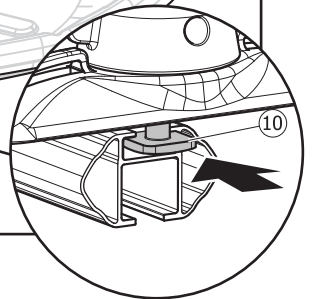
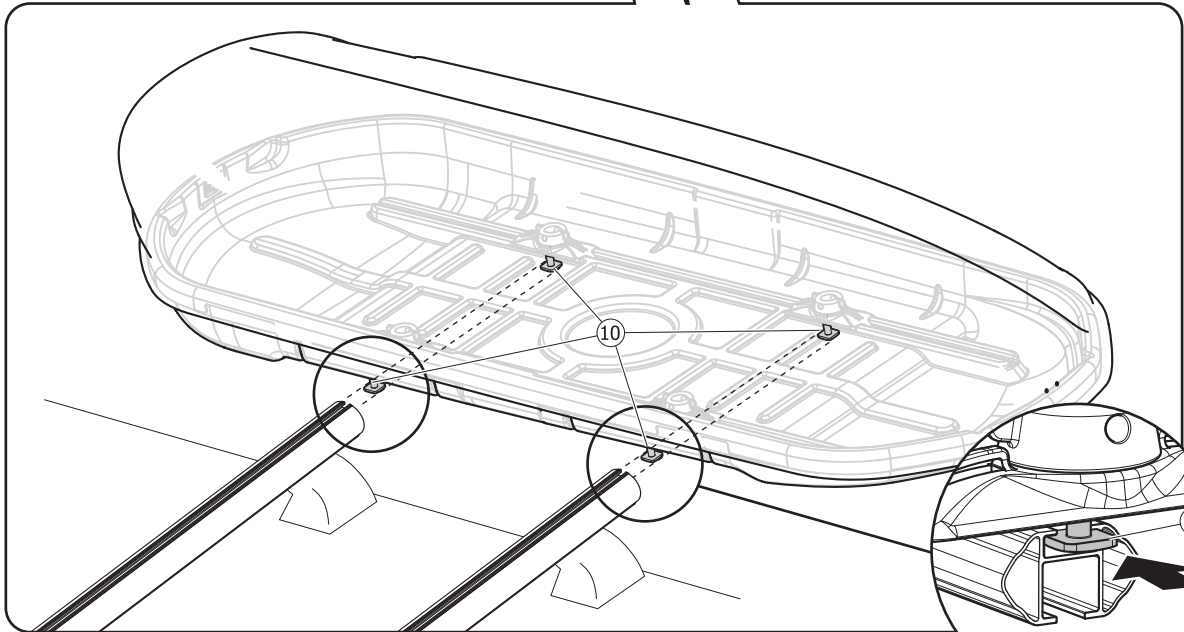
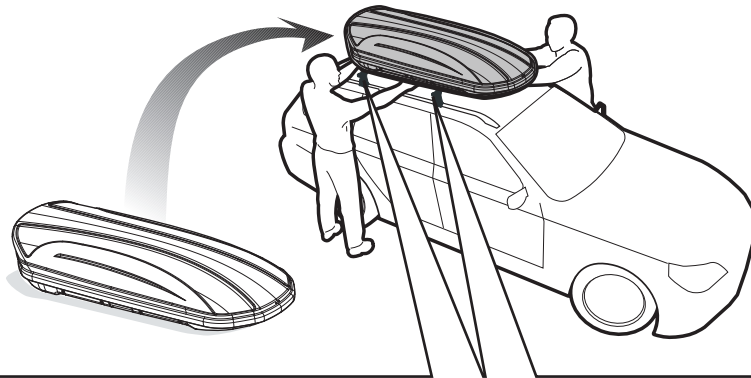
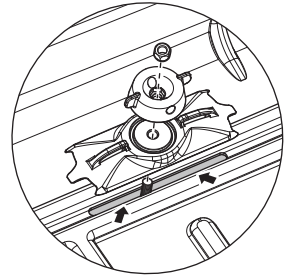
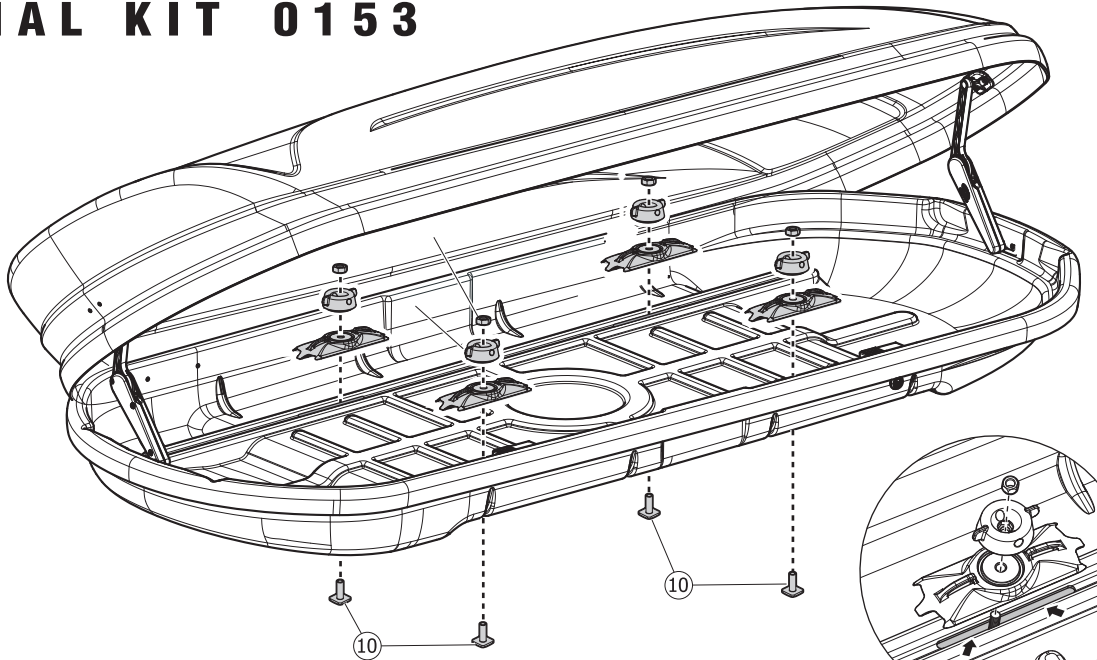
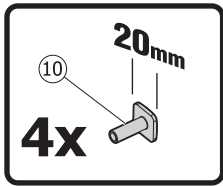
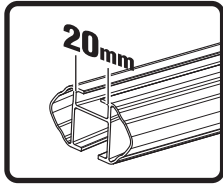

Cod. istr.	Rev.	Creata da	Approvata da
F10577	A	AS/LM	DM
	18/01/2011		