

1

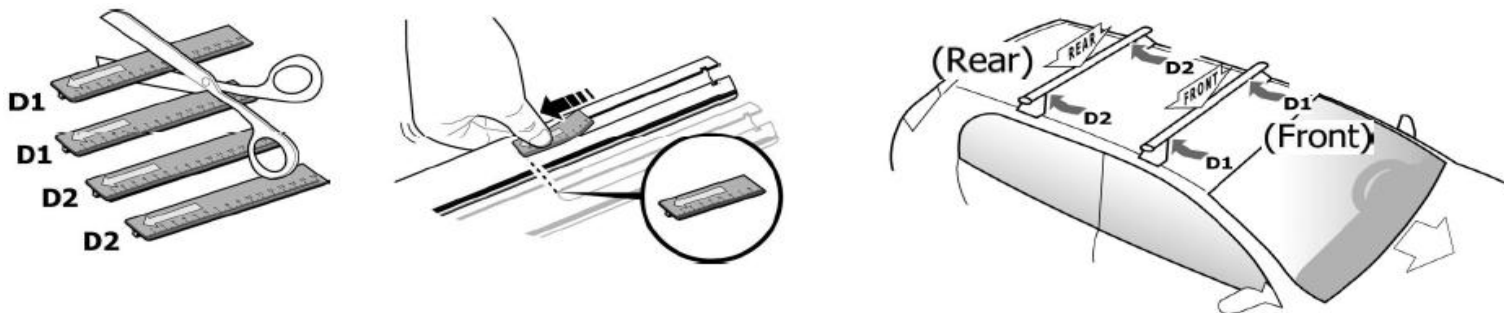

MANUFACTURER	MODEL CAR	DOORS	MODEL YEAR	D1	D2
FIAT	Punto II	3	03>07	10,6	14,1

2

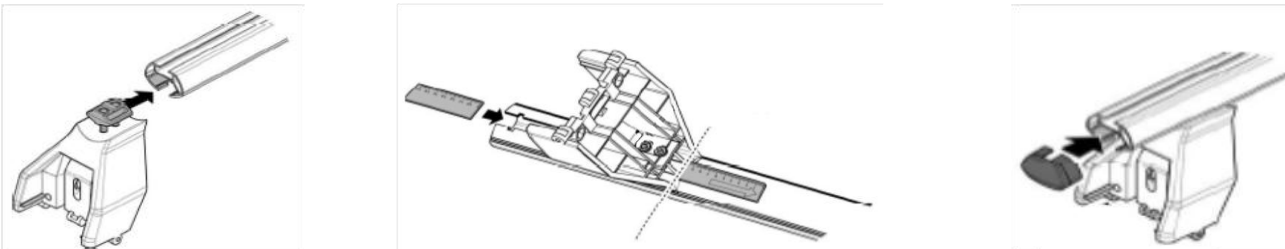

x4

3

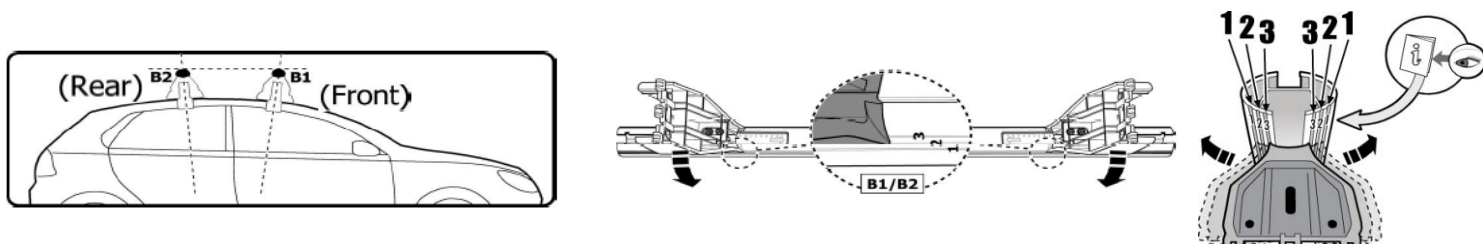

MANUFACTURER	MODEL CAR	DOORS	MODEL YEAR	B1	B2
FIAT	Punto II	3	03>07	1	2

4

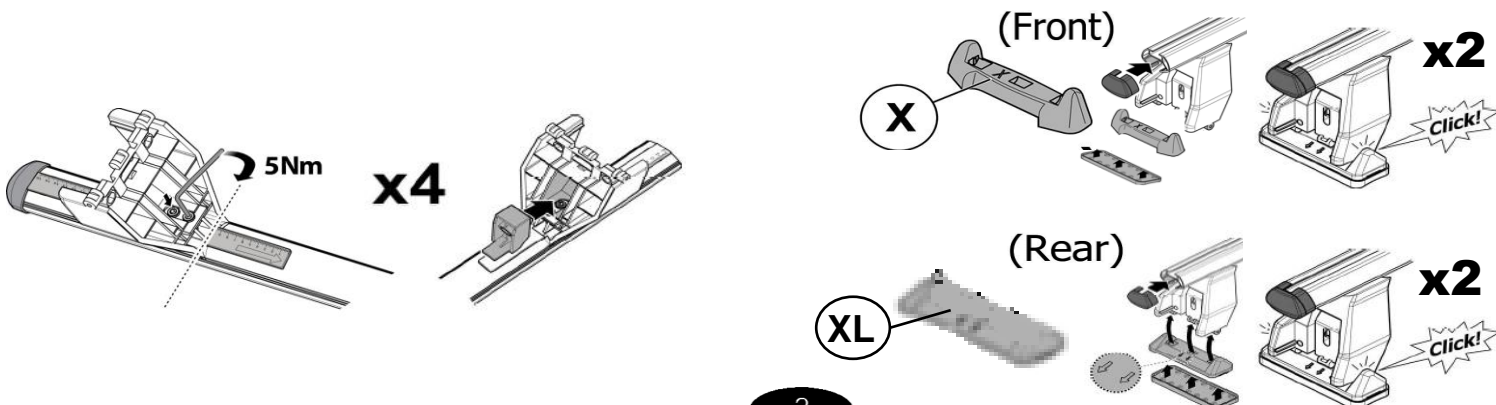

5

(Front)

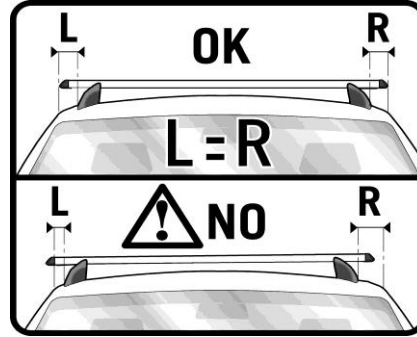
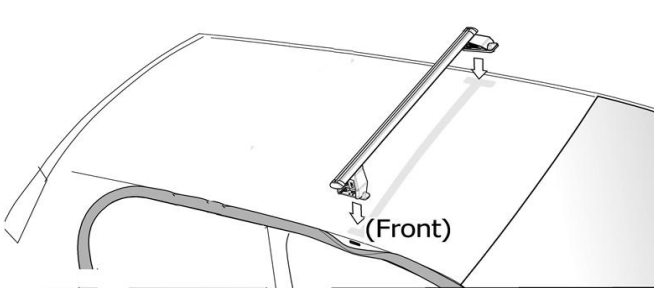
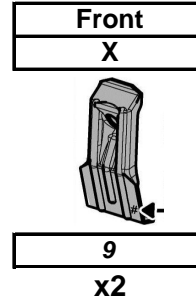
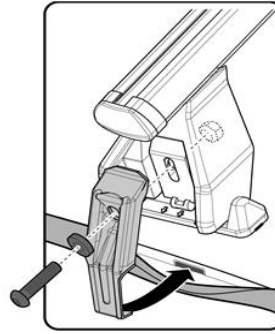
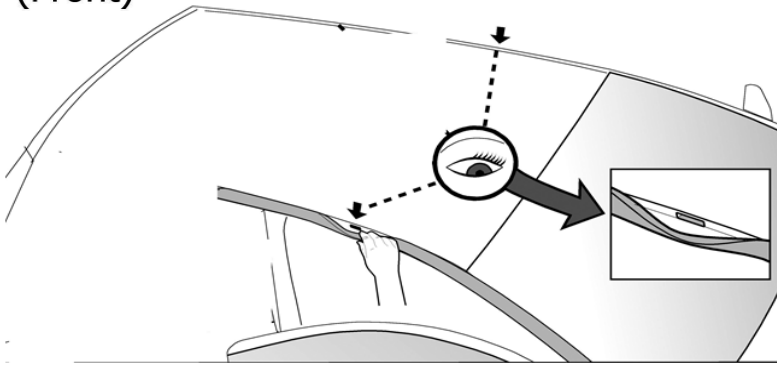

6

(Rear)

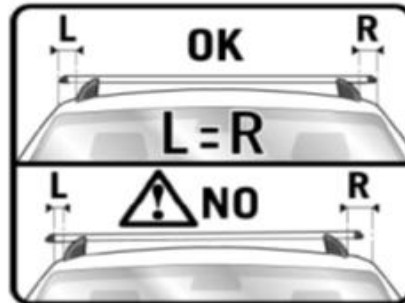

X2

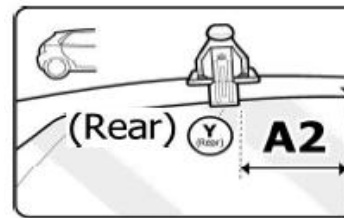
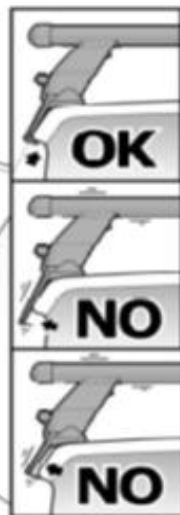
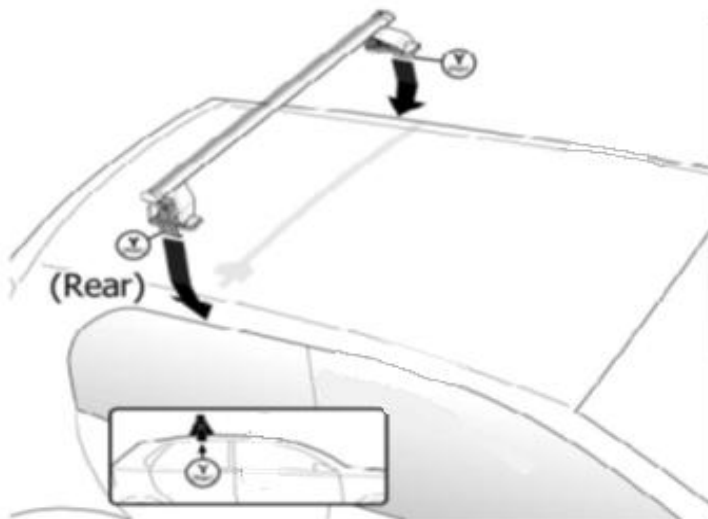
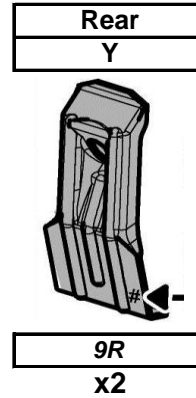

OR

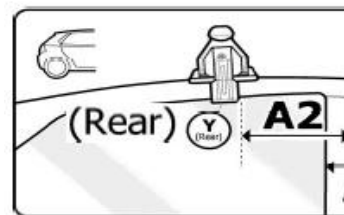

MANUFACTURER	MODEL CAR	DOORS	MODEL YEAR	A1	A2
FIAT	Punto II	3	03>07	X	X

X = predisposizione originale /original arrangement